

Diritti riservati

All rights reserved

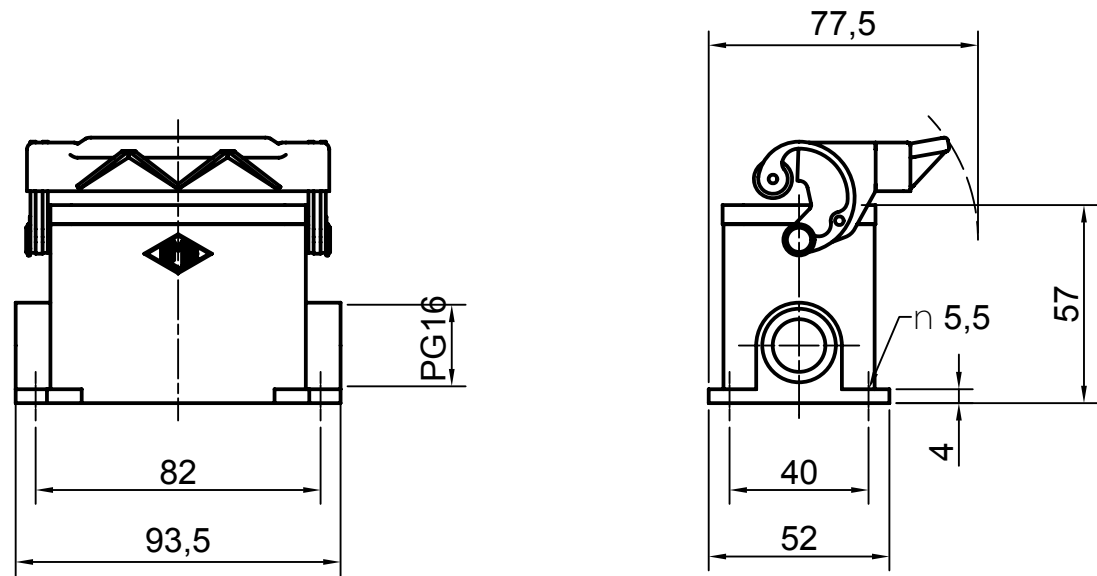

Date 04.01.2007	CMP 03 L		Scale
Sign.	surface mounting h. 1 lev. PG16 ins.		1:2
			